

MaxBlend 2+p[®]

LOW FLOW / HIGH FLOW

Instructions for Use

ENGLISH



NOTE: The latest edition of this operating manual can be downloaded from our website at www.maxtec.com

Read this entire manual before attempting to operate or service the MaxBlend 2+p. Attempting to operate the MaxBlend 2+p without fully understanding its features and functions may result in unsafe operating conditions.

CLASSIFICATION

Protection against electric shock	Class II
Ingress Protection	IPX1
Mode of operation	Continuous
Sterilization	See section 6.0
Applied Parts	Type B (Entire Device)
Flammable anesthetic mixture	See section 9.4

CAUTION: Federal law restricts this device to sale by, or on the order of, a medical professional.



Product Disposal Instructions:

The sensor, batteries, and circuit board are not suitable for regular trash disposal. Be sure to dispose of expired sensors in accordance with hospital, local, state, and federal regulations, or return to Maxtec for proper disposal or recovery. There are no special considerations for the disposal of the product packaging.

WARRANTY

The MaxBlend 2+p is designed for air/oxygen delivery. Under normal operating conditions, Maxtec warrants the MaxBlend 2+p to be free from defects of workmanship or materials for a period of three years from the date of receipt from Maxtec, provided that the unit is properly operated and maintained in accordance with Maxtec's operating instructions. Based on Maxtec's product evaluation, Maxtec's sole obligation under the foregoing warranty is limited to making repairs, or issuing credit, or replacement for equipment found to be defective. This warranty extends only to buyers purchasing new equipment directly from Maxtec, or through Maxtec's designated distributors and agents. Maxtec warrants the MAX-550E oxygen sensor in the MaxBlend 2+p to be free from defects in material and workmanship for a period of two years from Maxtec's date of shipment in a MaxBlend 2+p unit. Should a sensor fail prematurely, the replacement sensor is warranted for the remainder of the original sensor warranty period. Routine maintenance items, such as batteries, are excluded from warranty. Maxtec, and any other subsidiaries, shall not be liable to the purchaser or other persons for incidental or consequential damages to equipment that has been subject to abuse, misuse, misapplication, alteration, negligence, or accident. **THESE WARRANTIES ARE EXCLUSIVE AND IN LIEU OF ALL OTHER WARRANTIES, EXPRESSED OR IMPLIED, INCLUDING WARRANTY OF MERCHANTABILITY AND FITNESS FOR A PARTICULAR PURPOSE.**

NOTE: In order to obtain optimum performance from your MaxBlend 2+p, all operation and maintenance must be performed in accordance with this manual. Please read the manual thoroughly before using the MaxBlend 2+p, and do not attempt any repair or procedure that is not described herein. Maxtec cannot warranty any damage resulting from misuse, unauthorized repair, or improper maintenance of the instrument.

EMC Notice

This equipment uses, generates, and can radiate radio frequency energy. If not installed and used in accordance with the instructions in this manual, electromagnetic interference may result. The equipment has been tested and found to comply with the limits set forth in IEC 60601-1-2 for medical products. These limits provide reasonable protection against electromagnetic interference when operated in the intended use environments described in this manual.

MRI Notice

This equipment contains electronic and ferrous components, whose operation can be affected by intense electromagnetic fields. Do not operate the MaxBlend 2+p in an MRI environment or in the vicinity of high-frequency surgical diathermy equipment, defibrillators, or

shortwave therapy equipment. Electromagnetic interference could disrupt the operation of the MaxBlend 2+p.

WARNINGS

Indicates a potentially hazardous situation which, if not avoided, could result in death or serious injury.

The following warnings apply any time you operate or service the MaxBlend 2+p:

- ◆ **ALWAYS** confirm prescribed flow before administering to patient and monitor flow on a frequent basis.
- ◆ Always follow ANSI and CGA standards for medical gas products, flowmeters, and oxygen handling.
- ⊘ **DO NOT** operate the MaxBlend 2+p unless qualified personnel are in attendance to promptly respond to alarms, inoperative conditions, or sudden malfunctions.
- ◆ Patients on life-support equipment should be visually monitored at all times.
- ⊘ **DO NOT** ignore audible alarms of the MaxBlend 2+p. Alarms indicate conditions that require your immediate attention.
- ⊘ **DO NOT** use parts, accessories, or options that have not been authorized for use with the MaxBlend 2+p. Using unauthorized parts, accessories, or options may be harmful to the patient or damage the MaxBlend 2+p.
- ◆ Check all audible and visual alarms periodically to ensure they are operating properly. If an alarm fails to activate, contact your Maxtec Certified Service Technician. Be sure to review and, if necessary, re-set alarms and limits when patient's clinical condition changes or when the physician prescribes a change in oxygen therapy.
- ⊘ **DO NOT** operate the MaxBlend 2+p with the monitor powered off or without setting the adjustable alarms. All adjustable alarms must be set to ensure safe operation.
- ⊘ **DO NOT** steam autoclave or otherwise subject the MaxBlend 2+p to temperatures above 122°F (50°C).
- ◆ If either the air or oxygen source pressure is reduced or increased sufficiently to create a pressure differential of 20 PSI or more, an audible alarm will sound. This condition may significantly alter the FiO2 and flow output from the MaxBlend 2+p.
- ⊘ **DO NOT** tape, obstruct, or remove the alarm during clinical use.
- ⊘ **DO NOT** occlude the sensor port on the side of the MaxBlend 2+p.
- ◆ An air inlet/water filter is recommended for use with the MaxBlend 2+p. See section 6.1.
- ⊘ **DO NOT** use lubricants on the MaxBlend 2+p.
- ⊘ **DO NOT** use the MaxBlend 2+p until correct performance has been verified. See section 3.0.
- ◆ If a condition is detected that could possibly prevent the monitor from continuing to operate safely, it will sound an alarm. If, at any time, E0x (i.e. E02, E04, etc.) appears on the LCD refer to section 4.0, or contact a Maxtec Certified Service Technician.
- ◆ All service should be referred to a Maxtec Certified Service Technician.
- ◆ Maxtec recommends that the MaxBlend 2+p be serviced by Maxtec at a minimum of every three years, or if a leak or other performance problem is suspected.
- ◆ If the MaxBlend 2+p is dropped, follow the procedures outlined in section 3.0 for a performance check before reusing the device.
- ◆ When the unit is going to be stored (not in use for more than 30 days), always remove the batteries to protect the unit from potential damage due to battery leakage.
- ◆ Always replace batteries with high-quality, name-brand "AA" alkaline batteries.
- ◆ The low oxygen alarm can be set below 18%, and as low as 15%. See section 2.3 on setting alarms. This is in accordance with IEC 80601-2-55.
- ◆ To reduce the risk of cross contamination, only single use pressure monitoring line with moisture control tubing with an inline filter should be used with this device.

- ◆ The MaxBlend 2+p is not suitable for use with oxygen 93.
- ⊘ **DO NOT** allow liquids or debris to enter the pressure monitor port.
- ◆ Replace the pressure monitoring line if condensation build-up occurs.
- ◆ In order to reduce the potential issues associated with condensation, the pressure monitoring line connector should be positioned at least 10 inches (25cm) below the monitor.
- ⊘ **DO NOT** use for pressure in excess of 60 cmH₂O.
- ⊘ **DO NOT** connect pressure monitoring line to patient IV line.
- ◆ Secure the pressure monitoring line to avoid kinks and unintended disconnects.

To prevent risk of burns, fire, or injury to person(s):

- ◆ Mixed gases continuously bleed into the atmosphere at the oxygen concentration rate set at the control knob. Bleeding oxygen into any closed area could increase the risk of fire or explosion.
- ⊘ **DO NOT** operate this device in the presence of any flame or source of ignition, or when using devices such as electrosurgical equipment or defibrillators.
- ⊘ **DO NOT** operate the MaxBlend 2+p in the presence of flammable anesthetics or in an atmosphere of explosive gases. Operating the MaxBlend 2+p in flammable or explosive atmospheres may result in fire or explosion.
- ◆ Galvanic O₂ sensor electrolyte gel is acidic and may cause skin or eye irritation and/or burns. Take care when handling or replacing exhausted or damaged disposable O₂ sensors.
- ◆ Be sure to dispose of expired sensors in accordance with hospital, local, state, and federal regulations, or return to Maxtec for proper disposal or recovery.
- ⊘ **DO NOT** smoke in an area where oxygen is being used.
- ◆ When using the approved external power supply, functional batteries must also be installed in the device. The device will not operate solely on the external power supply.
- ◆ The MaxBlend 2+p may only be calibrated using 20.9% (room air) or 100 oxygen. Calibration at other concentrations will result in inaccurate readings.
- ⊘ **DO NOT** attempt to replace the oxygen sensor or batteries while the device is in use.
- ◆ Any serious incident that has occurred in relation to the device should be reported to the manufacturer and the competent authority of the European Member State in which the user and/or patient is established as applicable.
- ◆ Use only genuine Maxtec accessories and replacement parts. Failure to do so may seriously impair the monitor's performance. Repair or alteration of the MaxBlend 2+p beyond the scope of the maintenance instructions or by anyone other than an authorized Maxtec service person could cause the product to fail to perform as designed. No modification of this equipment allowed.
- ⊘ **DO NOT** use if gas leak is detected. Return device to Maxtec for repairs.
- ⊘ **DO NOT** use device for mixing of gases other than oxygen and medical air.
- ◆ The MaxBlend 2+p is not suitable for use with oxygen 93.

CAUTIONS

Indicates a potentially hazardous situation which, if not avoided, could result in minor or moderate injury and property damage.

- ⊘ **DO NOT** store the MaxBlend 2+p in hot areas for prolonged periods of time. Temperatures above 80°F (27°C) can shorten battery life.
- ◆ To minimize the potential for electrostatic shock, **DO NOT** use antistatic or electrically conductive hoses with the MaxBlend 2+p.

When cleaning the MaxBlend 2+p:

- ⊘ **DO NOT** use harsh abrasives.
- ⊘ **DO NOT** immerse the MaxBlend 2+p in liquid sterilizing agents or liquids of any kind.
- ⊘ **DO NOT** spray cleaning solution directly onto the sensor port, bleed muffler, or buzzer opening.
- ⊘ **DO NOT** allow cleaning solution to pool on the front panel, sensor port, or bleed muffler.
- ⊘ **DO NOT** sterilize the MaxBlend 2+p. Standard sterilization techniques may damage the blender.
- ⊘ **DO NOT** clean or dry the MaxBlend 2+p with a high pressure air gun. Applying high pressure air to the MaxBlend 2+p may damage components and render the system inoperable.



- ⊘ **DO NOT** over-clean the MaxBlend 2+p. Repeated use of a cleaning agent can cause residue build-up on critical components. Excessive residue buildup can affect the MaxBlend 2+p's performance.
- ◆ Dropping or severely jarring the sensor after calibration may shift the calibration point enough to require recalibration.
- ◆ Always operate the MaxBlend 2+p with clean, dry medical-grade gases. Contaminants or moisture can cause defective operation. Oxygen should have a minimum dewpoint of -80°F (-62°C) or moisture content less than 7.9 PPM (0.0059mg/L). Oxygen "purity" should be at least 99.0% and the air used should be medical-grade. Water vapor content must not exceed a dew point of 5°F (-15°C) below the lowest ambient temperature to which the delivery system is exposed.
- ◆ Particulate content must not exceed that which would be found immediately downstream of a 15 micron absolute filter. Refer to CGA commodity specifications G-4.3 and G7.1 for more information. Water vapor content of medical air or O₂ supply to the blender must not exceed 5.63 x 10³ milligrams H₂O per cubic meter of non-condensable gas.
- ⊘ **DO NOT** disassemble the MaxBlend 2+p. All service should be performed by a Maxtec Certified Service Technician.
- ◆ Be sure the MaxBlend 2+p is securely mounted. This device is usually mounted to a hospital rail system or an infusion stand. Dropping the device may cause injury or damage to the device.
- ◆ The outlets of this device are capable of delivering pressure as high as the inlet pressure. Ensure that the devices that carry the gas from the blender to the patient prevent excessive pressure to the patient.
- ⊘ **DO NOT** use the oxygen sensor if it appears to be damaged or is leaking. The oxygen sensors contain a weak acidic solution encapsulated in a plastic housing. Under normal operating conditions the solution (electrolyte) is never exposed.

NOTES

Indicates supplemental information to assist in the use of the device.

- ◆ The MaxBlend 2+p is tested for compliance with ISO 11195, and meets requirements regarding reverse gas flow as delivered.
- ◆ Applicable parts used in the MaxBlend 2+p have been cleaned and degreased for oxygen service. Any lubricants used are designed specifically for the application.
- ◆ As long as the absolute pressure of the gas mixture being monitored is constant, the MaxBlend 2+p will accurately read oxygen concentrations. However, if the absolute pressure varies the reading will fluctuate proportionately, as the sensor actually measures the partial pressure of oxygen in the mixture. The sensor readings will also change proportionately with barometric pressure changes; because of this, frequent calibration of the sensor is recommended.
- ◆ Users are advised to use pressure regulators which display the outlet pressure.
- ◆ All specifications assume the following standard environmental conditions, unless specified otherwise: ambient and sample gas temperatures of 77°F (25°C), barometric pressure of 30inHg (760mmHg), sea level altitude, ambient relative humidity of 50%, sample gas relative humidity of 0%.
- ◆ It is important to note that the oxygen concentration selection scale is provided only as a guideline for selecting O₂ concentrations. The clinician should use the MaxBlend 2+p's display panel to adjust the O₂ concentration to the desired setting.
- ◆ The alarm limits can be set to levels that would render them useless for a particular patient's clinical condition. Ensure that the delivered oxygen level and flow rate are set to values prescribed by the patient's physician. Also ensure that the high and low alarm limits are set to levels such that they will sound if the oxygen level is outside of safe limits. Be sure to review and, if necessary, re-set the alarm limits when the patient's clinical condition changes, or when the patient's physician prescribes a change in oxygen therapy.
- ◆ This device does not contain automatic barometric pressure compensation.
- ◆ Gas leaks that cause room air to mix with the gas sample may cause inaccurate oxygen readings. Ensure the O-rings on the sensor and flow diverter are in place and intact prior to use.

TABLE OF CONTENTS

CLASSIFICATION	2	3.0 PERFORMANCE CHECK	11
WARRANTY	2	3.1 Blender Safety Check.....	11
WARNINGS 	2	4.0 PRESSURE MONITOR TESTS	11
CAUTIONS 	3	4.1 Pressure Monitor Accuracy Test.....	11
NOTES	3	5.0 TROUBLESHOOTING	12
1.0 BASE UNIT DESCRIPTION	5	6.0 CLEANING AND DISINFECTING	13
1.1 Indication for Use.....	5	7.0 SERVICE AND MAINTENANCE	13
1.2 Essential Device Performance.....	5	7.1 Maintenance.....	13
1.3 MAX-550E Oxygen Sensor.....	5	7.2 Replacing O2 Sensor.....	13
1.4 Symbol Guide.....	5	7.3 Monitor Alarm Testing.....	13
1.5 Component Identification.....	6	8.0 ABBREVIATION GUIDE	13
1.6 Display Indicators.....	6	9.0 SPECIFICATIONS	13
1.7 Back View.....	7	9.1 Instrument Specifications.....	13
1.8 Requirements for Operating the Blender.....	7	9.2 Pressure Monitor Specifications.....	14
2.0 OPERATING PROCEDURES	7	9.3 Alarm Specifications.....	14
2.1 Setup and Installation.....	7	9.4 O2 Sensor Specifications.....	14
2.1.1 Battery Installation.....	7	10.0 FACTORS INFLUENCING CALIBRATION	14
2.1.2 Adjusting Alarm and Calibration Modes.....	8	10.1 Temperature Effect.....	14
2.1.3 MaxBlend 2+p Setup.....	8	10.2 Pressure Effect.....	14
2.1.4 Sensor Installation.....	8	10.3 Humidity Effect.....	14
2.2 Monitoring.....	8	10.4 Exposure to Anesthetic Gases.....	14
2.3 Alarm Setting Procedure.....	8	11.0 SPARE PARTS AND ACCESSORIES	14
2.3.1 Low Alarm Setting.....	8	12.0 THEORY OF OPERATION	15
2.3.2 High Alarm Setting.....	8	12.1 Operational Diagram.....	15
2.3.3 Smart Alarm Mode.....	9	12.2 Mixing Operation.....	15
2.3.4 Pressure Monitoring and Alarms.....	9	12.3 Gas Outlet.....	15
2.4 Basic Operation.....	9	12.4 Alarm/Bypass Function.....	15
2.4.1 Pressure Monitoring Operation.....	9	13.0 FLOW CHARACTERISTICS	15
2.5 Alarm Conditions and Priorities.....	9	14.0 ELECTROMAGNETIC COMPATABILITY	16
2.5.1 Multiple Alarms.....	10		
2.6 Backlight Operation.....	10		
2.7 External Power Supply Operation.....	10		
2.8 Calibration Procedures.....	10		
2.8.1 Calibration to 100% Oxygen.....	10		
2.8.2 Calibration to Room Air.....	10		
2.8.3 Zero Calibration.....	11		
2.9 Flowmeter Operation.....	11		

1.0 BASE UNIT DESCRIPTION

The MaxBlend 2+p is a compact air/oxygen gas mixing device with an integrated flowmeter which incorporates the use of a battery powered oxygen and pressure monitor. This device should only be used by clinically trained operators with sufficient knowledge, training and understanding of this manual. The gas mixing device (blender) provides precise mixing of medical-grade air and oxygen, while the oxygen monitor measures the selected oxygen concentrations from the blender's gas flow and displays these measured concentrations on a digital display. The pressure reading displayed is a 2 second mean pressure, relative to the ambient conditions, ie. referenced to ambient as 0. The monitor provides user adjustable low and high alarm limits which, when exceeded, trigger an audible and visual alarm. The associated low and high alarm limits are displayed to the left and right of the readings respectively. The monitor indirectly contacts the patient through the breathing gas pathway via the MAX-550 Oxygen sensor membrane.

1.1 Indication for Use

The MaxBlend 2+p is intended to provide a continuous air/oxygen gas mixture and to continuously monitor the concentration of oxygen and pressure being delivered to infant, pediatric, and adult patients. It is a restricted medical device intended for use by qualified, trained personnel, under the direction of a physician, in professional healthcare settings, i.e., hospital, subacute, and nursing-care facilities where the delivery and monitoring of air/oxygen mixtures is required. This is not intended as a life supporting device or life sustaining device.

1.2 Essential Device Performance

Essential performance are the operating characteristics of the device, without which would result in an unacceptable risk. The following items are considered essential performance:

- Oxygen measurement accuracy
- Pressure measurement accuracy
- Operation of visible and audible alarms
- Operation of blender bypass
- Operation of reverse gas flow protection

1.3 MAX-550E Oxygen Sensor

The MAX-550E is a galvanic, partial pressure sensor that is specific to oxygen. It consists of two electrodes (a cathode and an anode), a teflon membrane and an electrolyte. Oxygen diffuses through the teflon membrane and immediately reacts electrochemically at a gold cathode. Concurrently, oxidation occurs electrochemically at a lead anode, generating an electrical current and providing a voltage output. Electrodes are immersed in a unique gelled weak acid electrolyte, which is responsible for the sensor's long life and motion insensitive characteristic. Since the sensor is specific to oxygen, the current generated is proportional to the amount of oxygen present in the sample gas. When no oxygen is present, there is no electrochemical reaction, and therefore, negligible current is produced. In this sense, the sensor is self-zeroing.





CAUTION: The MAX-550E oxygen sensor is a sealed device containing a mild acid electrolyte and lead (Pb). These materials are hazardous waste constituents. Be sure to dispose of expired sensors in accordance with hospital, local, state and federal regulations, or return to Maxtec for proper disposal or recovery.





















































NOTE: The MaxBlend 2+p monitoring system indirectly contacts the patient through the breathing gas pathway.

CAUTION: Dropping or severely jarring the sensor after calibration may shift the calibration point enough to require recalibration.

1.4 Symbol Guide

The following symbols and safety labels are found on the MaxBlend 2+p and/or labeling:

	ON/OFF Key		ON/OFF Key
	Medical Device		Unique Device Identifier

	Calibration/Zero Key		Silent Key
	Calibration Reminder		Smart Alarm Key
	Unlock Key		Low Alarm Indicator
	Backlight Key		Alarm Silence Indicator
	High Alarm Indicator		UP (High Alarm Key)
	Smart Alarm Mode Indicator		Attention, consult accompanying documents (blue background with white pictogram)
	DOWN (Low Alarm Key)		Caution
	Power Supply Indicator		MR Unsafe (red circle/diagonal with black pictogram)
	Battery Indicator		Federal law (USA) restricts this device to sale by or on order of a physician.
	Warning (yellow background with black triangle/pictogram)		Meets ETL standards
	Do Not (red circle/diagonal)		Serial Number
	Below 18% Alarm Indicator		Catalog Number
	Inlet		Do not throw away. Follow local guidelines for disposal
	Outlet		Liters Per Minute
	Read Flow at Center of Ball		Ingress Protection Rating
	Oxygen Percent		Corrosive
	Oxygen Enriched Air		Type B Applied Parts
	Use No Oil		Storage Temperature Range
	Manufacturer		Combined UL / CSA Mark
	Direct Current		Complies with Directive 2011/65/EU
	Pressure Mode		Date of Manufacture
	Oxygen Mode		Single Use
	Two means of patient protection (double insulated)		Humidity Limitation
	For use in dry indoor locations.		Power Plug Polarity
	Regulatory Compliance Mark		Batch Code
	Non-DEHP		Not Manufactured with Natural Rubber Latex

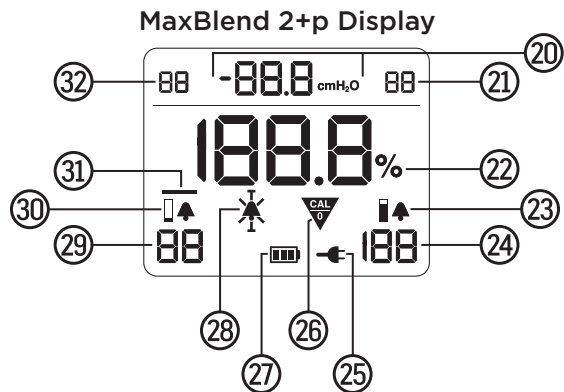
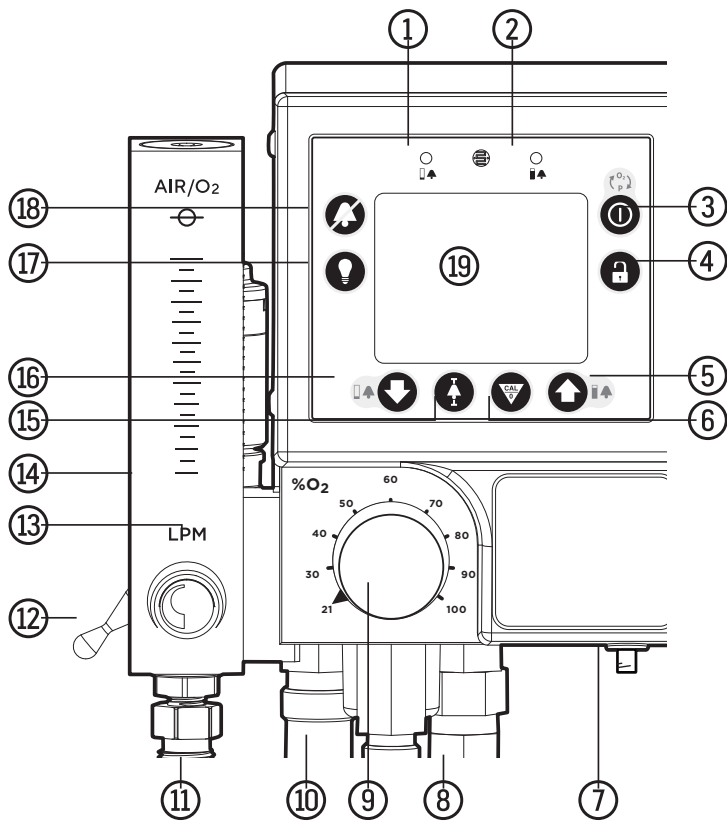







1.5 Component Identification

- ① **LOW ALARM LED** — In a low alarm condition, the “LOW ALARM” LED will flash twice a second, accompanied by the audio buzzer.
- ② **HIGH ALARM LED** — In a high alarm condition, the “HIGH ALARM” LED will flash twice a second, accompanied by the audio buzzer.
- ③ **ON/OFF AND MODE KEY** — This key is used to turn the device on or off. To turn the device OFF, the button must be held while a rapid 3-2-1 countdown takes place to prevent accidental power-off. This button is also used to toggle between oxygen (O₂) and pressure (P) modes when the device is unlocked.
- ④ **UNLOCK KEY** — The unlock key is used to lock and unlock the instrument.
- ⑤ **UP (ALARM HIGH) KEY** — The up key is used in setting the high alarm limit. The device must be in the unlocked state for the key to operate. See section 2.3.2 for instructions on setting the high alarm limit.
- ⑥ **CALIBRATION KEY** — This key is used to calibrate or zero the device. The device must be in the unlocked state for the key to operate. See section 2.8 for instructions on calibrating.
- ⑦ **PRESSURE MONITOR PORT** — This port is used for connecting pressure monitoring line for pressure monitoring.
- ⑧ **O₂ INLET FITTING** — An O₂ fitting for connection to the O₂ inlet hose from the gas source.
- ⑨ **OXYGEN CONCENTRATION SELECTOR CONTROL** — A knob which allows for selections of mixed oxygen concentrations from 21% to 100%.
- ⑩ **MEDICAL AIR INLET CONNECTOR** — An air fitting for connection to an air inlet hose from the air gas source.
- ⑪ **FLOWMETER OUTLET** — A fitting for connection to the patient delivery tubing.

- ⑫ **BLEED TOGGLE SWITCH** — The Bleed Toggle Switch turns on the auxiliary bleed. For the blender to accurately mix the oxygen and air, the bleed must be turned on whenever the total flow delivered to the patient is less than 15 LPM for high flow model, or less than 3 LPM for low flow model.
- ⑬ **FLOW CONTROL KNOB** — The flow control knob controls the flow of gas exiting the flowmeter.
- ⑭ **OXYGEN FLOWMETER** — Measures the flow of mixed gas exiting the flowmeter outlet.
- ⑮ **SMART ALARM KEY** — The smart alarm key is used to help set the High-Low Alarm window quickly. This automatically sets oxygen alarms at $\pm 3\%$ or pressure alarms at ± 2 cmH₂O.
- ⑯ **DOWN (LOW ALARM) KEY** — The down key is used in setting the low alarm limit. The device must be in the unlocked state for the key to operate. See section 2.3.1 for instructions on setting the low alarm limit.
- ⑰ **BACKLIGHT KEY** — The backlight key will manually activate the backlight for 30 seconds. See section 2.6 for more information on backlighting operation.
- ⑱ **SILENT KEY** — In an alarm condition, pressing the SILENT key will deactivate the audio alarm for 2 minutes.
- ⑲ **LCD DISPLAY** — The digit liquid crystal display (LCD) provides direct readout of oxygen concentrations and pressures. The digits also display error codes, alarm set modes, and calibration codes as necessary.

1.6 Display Indicators

- ⑳ **PRESSURE READING** — Current pressure reading of the sample in centimeters of water (cmH₂O).

- ②1 **HIGH PRESSURE ALARM LIMIT** — High pressure alarm setpoint. Audible and visual alarms will trigger when this limit is exceeded. Double dashes (--) indicates the alarm is inactive.
- ②2 **OXYGEN CONCENTRATION** — Current oxygen concentration percentage from the oxygen sensor.
- ②3 **HIGH ALARM INDICATOR** —  High alarm symbol used for identifying the high alarm setpoints and when a high alarm is triggered.
- ②4 **OXYGEN HIGH ALARM LIMIT** — High oxygen alarm setpoint. Audible and visual alarms will trigger when this limit is exceeded. Double dashes (--) indicates the alarm is inactive.
- ②5 **POWER SUPPLY INDICATOR** — Indicates when the device is connected and receiving power from an external power supply. **NOTE:** Batteries are still required for proper operation.
- ②6 **CALIBRATION REMINDER** —  The calibration reminder symbol is located at the bottom of the display. This symbol will be display when one week has elapsed from the previous oxygen calibration.
- ②7 **BATTERY INDICATOR** —  The Battery Indicator is located at the bottom of the display and bars indicate approximate battery level remaining.
- ②8 **ALARM SILENCE/SMART ALARM INDICATOR** — When the Silent key is pressed the indicator will display with cross bars  to alert condition. When the Smart Alarm key is pressed the indicator  will display with T-bars to alert condition.
- ②9 **OXYGEN LOW ALARM LIMIT** — Low oxygen alarm setpoint. Audible and visual alarms will trigger when this limit is exceeded.
- ③0 **LOW ALARM INDICATOR** —  Low alarm symbol used for identifying the low alarm setpoints and when a low alarm is triggered.
- ③1 **<18% ALARM INDICATOR** — The <18% alarm indicator is located above the Low Alarm Indicator digits. When the low alarm setting is set below <18%, the indicator will flash each second to alert the operator of this special condition. See section 2.3.1 for setting this low alarm condition.
- ③2 **LOW PRESSURE ALARM LIMIT** — Low pressure alarm setpoint. Audible and visual alarms will trigger when this limit is exceeded. Double dashes (--) indicates the alarm is inactive.

1.7 Back View

- ③3 **BATTERY COMPARTMENT** — The MaxBlend 2+p is powered by four “AA” alkaline batteries.
- ③4 **SENSOR CABLE** — The cable connects the MaxBlend 2+p to the Max-550E Sensor.
- ③5 **SENSOR WITH DIVERTER** — The sensor with flow diverter is designed to fit into a port behind the flowmeter.
- ③6 **O₂ SENSOR PORT** — A sampling port for the oxygen sensor. It allows mixed gas from the blender to flow over the sensor membrane.
- ③7 **PRESSURE DIFFERENTIAL REED ALARM** — An audible alarm which, when activated, indicates that an unacceptable pressure differential exists between the two gas source pressures.
- ③8 **AUXILIARY MIXED GAS OUTLET** — The outlet can be used as power take off.
- ③9 **AUXILIARY MIXED GAS OUTLET** — The outlet can be used to add additional flowmeters.

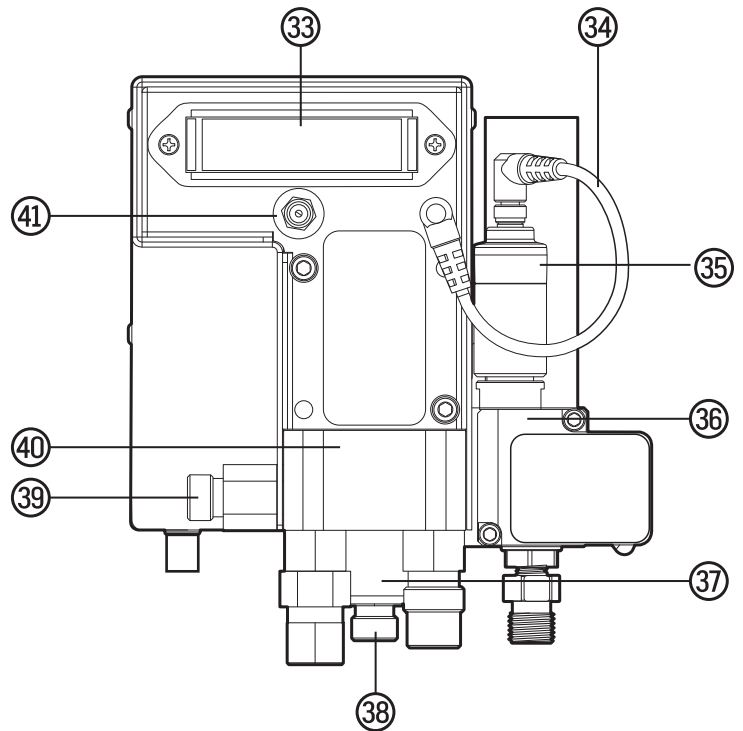

- ④0 **MOUNT ADAPTER** — An adapter which allows the MaxBlend 2+p to be mounted onto a bracket for attaching to a rail or ventilator system.
- ④1 **EXTERNAL POWER SUPPLY PORT** — The port provides connection for the external power adapter. See section 2.7 for more information on the power supply.

1.8 Requirements for Operating the Blender

PRESSURIZED OXYGEN: The compressed oxygen source must provide clean, dry, medical-grade oxygen at the pressure specified in Section 8.0.

PRESSURIZED AIR: The compressed air source must provide clean, dry, medical-grade air at the pressure specified in Section 8.0.

2.0 OPERATING PROCEDURES

2.1 Setup and Installation

2.1.1 Battery Installation

All MaxBlend 2+p units are powered by four “AA” alkaline batteries (4 x 1.5 Volts) and are shipped without the batteries installed. Only name-brand batteries should be used. Batteries should be replaced by trained service personnel.

To install the batteries:

Open the battery drawer by squeezing inward on both tabs as shown in the figure below. If you have difficulty squeezing the tabs in with your fingers, use two flat screwdrivers or two coins. Remove the battery drawer completely from the MaxBlend 2+p. Install four new, “AA” alkaline batteries into the unit, observing the orientation shown on the plastic inside the drawer. Slide the drawer back in with the batteries facing upward. Press in on the drawer until both tabs latch into place.

When batteries are replaced, the unit will start up and perform an automatic calibration. Ensure calibration is performed as directed in Section 2.8.

 **WARNING:** Battery replacement by inadequately trained personnel could result in a safety hazard.

⚠ WARNING: Electrical shock or damage to the equipment may occur if an inappropriate external power supply is used. Maxtec recommends using only the Maxtec MaxBlend 2+p External Power Supply—R230P10.

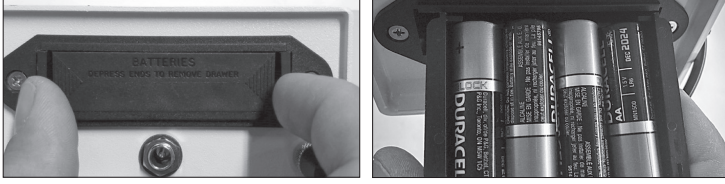

BATTERY ICON : The battery bars indicate the approximate remaining power in the batteries.

Indicator	Battery Level
	100%
	80%
	60%
(1 bar flashing)	40%
(Outline flashing)	20%
(Outline flashing + E04)	0%

2.1.2 Adjusting Alarm and Calibration Modes

You must select oxygen O_2 or pressure P mode prior to adjusting alarms or performing a calibration/zero. To set the device mode:

1. Unlock the device by pressing the unlock key.
2. Once unlocked the display will flash and you can toggle either oxygen O_2 or pressure P mode by pressing the power/mode key.
3. The respective alarms and calibration may now be performed.

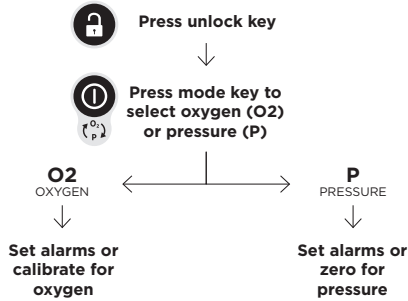

2.1.3 MaxBlend 2+p Setup

1. Connect the pressurized air source to the Air Inlet Connector.
2. Connect the pressurized oxygen source to the O_2 Inlet Fitting.
3. Flush gas at the highest possible flow rate through the blender for at least one minute to eliminate any particulate that may have been introduced into the system during handling and installation.

2.1.4 Sensor Installation

1. Attach the flow diverter onto the oxygen sensor.
2. Place the sensor into the sensor port located behind the flowmeter.

3. Attach the sensor cable directly to the sensor and the sensor jack on the back of the monitor enclosure. Ensure the cable is fully inserted into both connections.
4. Calibrate the sensor prior to use according to the calibration procedures in section 2.8

2.2 Monitoring

Before use on a patient, the oxygen concentration of the delivered gas should be checked at the setting intended for use.

1. To begin monitoring, press the ON/OFF key located on the front panel. Monitoring will begin immediately.
2. Should oxygen level exceed either the HIGH or LOW alarm set points, the alarm indicator on the front panel will illuminate indicating either a high or low oxygen condition. The alarm will cease when oxygen levels are within limits, or the limits are adjusted.

NOTE: The MaxBlend 2+p will monitor the oxygen concentration of the gas delivered from the blender regardless of which outlet port is in use. Therefore, the integrated flowmeter has ultimately no effect on the oxygen sensing.

2.3 Alarm Setting Procedure

2.3.1 Low Alarm Setting

To adjust the low alarm setting:

1. Press the Unlock key to unlock the keypad. Note the LOW, SMART ALARM, CAL, and HIGH icons will begin to flash indicating the SET OPERATING MODE.
2. Press the DOWN (Low Alarm) key on the keypad.

Select oxygen or pressure by pressing the power/mode key .

NOTE: The Low Alarm digits begin to flash indicating the Low Alarm manual setting.

3. Use the UP and DOWN keys to set the low alarm to the desired value. Pressing the arrow keys changes the value in 1% or 1 cmH₂O increments. If the keys are held down for more than 1 second the display will scroll at a rate of 1% or 1 cmH₂O per second.

NOTE: If 30 seconds elapse between key actuations, the system will store the latest low alarm setting and will revert to normal operation. If this occurs inadvertently, simply repeat the alarm setting procedure.

There is a special condition that allows the low oxygen alarm to be set below 18%. To access this condition, press the DOWN arrow key for three seconds while the low alarm reading displays 18%. The alarm setting can now be adjusted to 17, 16, or 15%. A bar will blink above the setting to provide further indication that the alarm has been set to this special <18% condition.

The low alarm value cannot be set lower than 15%, nor can it be set closer than 1% from the high alarm value. For example, if the high alarm is set at 25%, the system will not accept a low alarm setting greater than 24%.

When the low alarm value is set, press the Unlock key again to accept the low alarm setting and return to normal operation.

NOTE: The default low alarm setting is 18% O_2 and off (--) for pressure. Removing the batteries or shutting the unit OFF will reset the low alarm limit to 18% if it is set to <18%.

2.3.2 High Alarm Setting

To adjust the high alarm setting:

1. Press the Unlock key to unlock the keypad. Note the LOW, SMART ALARM, CAL and HIGH icons will begin to flash indicating the SET OPERATING MODE.

Select oxygen or pressure by pressing the power/mode key .

2. Press the UP (High Alarm) key on the keypad.

NOTE: The High Alarm digits begin to flash indicating the High Alarm manual setting.

- Use the UP and DOWN keys to set the high alarm to the desired value. Pressing the arrow keys changes the value in 1% or 1 cmH₂O increments. If the keys are held down for more than 1 second the display will scroll at a rate of 1% or 1 cmH₂O per second.

NOTE: If 30 seconds elapse between key actuations, the system will store the latest high alarm setting and will revert to normal operation. If this occurs inadvertently, simply repeat the alarm setting procedure.

- When the high alarm setting is set above 100% or 60 cmH₂O the high alarm will indicate two dashes --. This special condition turns off or deactivates the high alarm.
- When the high alarm value is set, press the Unlock again to accept the high alarm setting and return to normal operation.





NOTE: The default high alarm setting is 50% oxygen and 15 cmH₂O pressure. Removing the batteries will reset the high alarm limits to 50% and 15 cmH₂O.

2.3.3 Smart Alarm Mode

NOTE: Smart alarms function as alarm guardrails which simultaneously set the low and high alarms to $\pm 3\%$ oxygen or ± 2 cmH₂O of the current oxygen or pressure reading. This range can be broadened by pressing the up button or narrowed by pressing the down button.

- Press the Unlock Key  to unlock the keypad. Note the LOW, SMART ALARM, CAL, and HIGH icons will begin to flash indicating the SET OPERATING MODE.

Select oxygen or pressure by pressing the power/mode key .

- Press the Smart Alarm key  on the keypad. Note the LOW digits, Alarm Mode and HIGH digits begin a slow flash indicating SMART ALARM MODE. current reading $+3\%$ or $+2$ cmH₂O (rounded to the nearest integer). The low alarm will now be set to be equal to the current reading -3% or -2 cmH₂O (rounded to the nearest integer but never lower than 18%).
- Pressing of the UP key  will add 1% to the high alarm setting and subtract 1% from the low alarm setting. Pressing the DOWN key  will subtract 1% from the high alarm setting and add 1% to the low alarm setting. In other words, the UP key widens the alarm band and the DOWN key tightens the alarm band. This feature will not set the alarm levels above 100% or below 18% for oxygen or above 60 cmH₂O or below 1 cmH₂O for pressure.
- Once the desired alarm settings are attained, press the Unlock key  again to save the settings and return to normal operation mode. If 30 seconds elapse without a key press by the user, the device will automatically save the latest alarm settings and return to normal operation mode.

2.3.4 Pressure Monitoring and Alarms

The monitor displays the mean pressure using a 2 second average. Pressure monitoring begins immediately once the device is powered on. The device will activate an audible and visual (LED) alarm whenever the alarm limits are exceeded, however the pressure alarms are delayed by 3 seconds to allow for momentary fluctuations in pressure and reduce unnecessary alarm disturbances.

By default, the pressure alarms are set to off (--) for the LOW alarm and 15 cmH₂O for the HIGH alarm. Pressure alarms are automatically saved in the device memory and recalled to the last settings whenever the device is powered on/off. Alarm default setpoints are only reset by removing and re-installing the batteries.

2.4 Basic Operation

To check the oxygen concentration of the delivered gas:

- Ensure the sensor is connected to the flow diverter and inserted completely in the sensor port behind the flowmeter.
- Set the oxygen blender control knob to the desired oxygen setting.
- Using the ON/OFF key , make sure the unit is in the power on mode.
- Allow the oxygen reading to stabilize.
- Adjust the flowmeter to the desired flow rate. Read the flow rate at the center of the float ball.

2.4.1 Pressure Monitoring Operation

The monitor measures pressure using pressure monitoring line with moisture control tubing (pressure monitoring line) that includes an inline filter. The filter protects the monitor from

moisture and reduces the risk of cross contamination. The pressure monitoring line is intended to be used on an individual patient during a single procedure then disposed of. The pressure monitoring line must be discarded and replaced between each patient and procedure. When in use on a single patient in an ongoing procedure, it must be discarded and replaced every 30 days or sooner. The pressure monitoring line is NOT intended to be reprocessed.

To begin pressure monitoring:



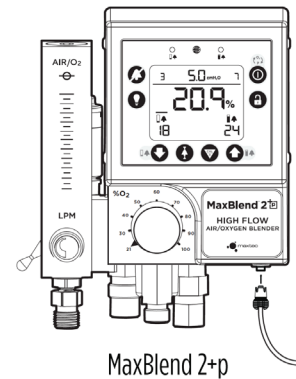

- Perform a zero calibration if the monitor displays a non-zero pressure reading. (See Section 2.8.3)
- Locate the pressure monitor port on the device and push in the connector of pressure monitoring line until it clicks into place.



- Locate and attach the other end of the pressure monitoring line into the circuit to be monitored using the Luer connector.
- Adjust the low and high pressure alarms to the desired range. Alternatively, the pressure alarms may be set automatically using the smart alarm button.
- The device will now monitor pressure between the set range.

WARNING: In order to reduce the potential issues associated with condensation in the pressure monitoring line, the pressure monitoring line connector should be positioned at least 10 inches (25 cm) below the monitor.

WARNING: To reduce the risk of cross contamination, only single use pressure monitoring line with an inline filter should be used with this device.

-  **DO NOT** allow liquids or debris to enter the pressure monitor port.
-  Replace the pressure monitoring line if condensation build-up occurs.
-  **DO NOT** use for pressure in excess of 60 cmH₂O.
-  **DO NOT** connect pressure monitoring line to patient IV line.
-  Secure the pressure monitoring line to avoid kinks and unintended disconnects.

2.5 Alarm Conditions and Priorities

In the event of either a low alarm or high alarm condition, the corresponding LED will begin to flash, accompanied by the audio buzzer. Pressing the Silent key  will deactivate the buzzer, but the LED and the alarm value digits on the display will continue to flash until the alarm condition has been rectified. If the alarm condition still exists 120 seconds after silencing the audio buzzer, the beeper will start to sound again.

An alarm condition will remain until the actual oxygen concentration or pressure is within the alarm range.

To help differentiate the level of priority, the monitor provides three unique audible sequences.

ALARM	ALARM PRIORITY	LOW ALARM LED	HIGH ALARM LED	AUDIBLE ALARM	AUDIBLE ALARM REPEAT
Line Power Plugged In	Informational	Off	Off	2 Pulses	No Repeat
Line Power Unplugged	Informational	Single Yellow Pulse	Single Yellow Pulse	2 Pulses	No Repeat
External DC Power Supply Voltage Out of Range	Informational	Solid Yellow	Solid Yellow	2 Pulses	Every 35 Sec.
No oxygen sensor attached (E02)	Medium	Pulsing Yellow	Pulsing Yellow	3 Pulses	Every 25 Sec.
Battery Voltage too low for device to operate (E04)	Medium	Pulsing Yellow	Pulsing Yellow	3 Pulses	Every 25 Sec.
Oxygen/pressure level above the high alarm setting	Medium	Off	Pulsing Yellow	3 Pulses	Every 25 Sec.
Oxygen/pressure level below the low alarm setting	Medium	Pulsing Yellow	Off	3 Pulses	Every 25 Sec.
Oxygen level below the low oxygen alarm setting and lower than 18%	High	Pulsing Red	Off	5+5 Pulses	Every 15 Sec.

2.5.1 Multiple Alarms

When multiple alarms occur the LOW or HIGH alarm LED will flash respectively along with the numeric alarm values that have been triggered. If both a LOW and HIGH alarm are triggered at the same time the highest priority LED and tone will be produced. The alarm LEDs and tones will automatically default to the highest priority alarm. Alarms will automatically clear once the reading has returned within the specified alarm window.

2.6 Backlight Operation

To turn on the backlighting:

1. When the unit is on, pressing the Backlight button will turn the backlighting on for 30 seconds. An additional press will turn off the backlighting.
2. If the device is being used in a dark location, any button press will activate the backlight.

 **CAUTION:** Excessive use of the backlight can reduce the life of the batteries.

2.7 External Power Supply Operation

To extend the life of the batteries, an external Maxtec approved 7.5V DC external power supply can be purchased. Once connected to the unit, total power is supplied by the power supply. Batteries are still required in the unit and will provide emergency power in the event main AC power is lost.

NOTE: Use only the Maxtec external power supply described in section 10.0.

NOTE: The power supply is not a battery charger.

 **DO NOT** use rechargeable batteries.

 **WARNING:** Do not position the equipment in a way that it would be difficult to unplug the power supply. Unplugging the power supply is the only means of disconnection or isolating the equipment from AC mains power.

2.8 Calibration Procedures

2.8.1 Calibration to 100% Oxygen

The MaxBlend 2+p should be calibrated before being placed into clinical use. Thereafter, Maxtec recommends calibration of the unit on a weekly basis. Frequent calibration will have no adverse effect on the performance of the MaxBlend 2+p. Calibration should also be performed upon replacement of a sensor.



The sensor is best calibrated while mounted in the MaxBlend 2+p sensor port. As in normal operation, the oxygen sensor responds best when installed in a vertical position with the sensor facing down.

Changes in barometric pressure can affect the oxygen reading. A 1% change in the barometric pressure results in an error of 1% of the actual reading. (Example: If you are reading a 50% oxygen mix and the barometric pressure drops from 1000mbar to 990mbar the reading will drop to 50% x (990/1000) = 49.5%). Maxtec recommends that you recalibrate after changing point-of-use elevation by more than 500 feet (150m).

It is best to calibrate the MaxBlend 2+p using the sensor port with a technical grade oxygen standard (99.0% or better). Calibration of the unit with room air is less accurate over the full FiO2 operating range.

Calibration is recommended if the user is unsure when last calibration procedure was performed or if the measurement value displayed is in question.



To calibrate to 100% oxygen:

1. Connect the oxygen supply line (pressure differential alarm may sound). Verify the sensor is plugged into the O2 sensor port and connected to the sensor cable. **DO NOT** connect air supply line at this time.
2. Using the ON/OFF key , make sure the MaxBlend 2+p is in the power on mode.
3. Rotate the FiO2 control knob to the 100% stop. Allow a few minutes for the reading to stabilize.
4. Press the Unlock key  to unlock the keypad. Note the LOW, SMART ALARM, CAL, and HIGH icons will begin to flash indicating the SET OPERATING MODE. Verify device is in O2 mode.
5. Press the Calibration key  on the keypad. The word "CAL" will appear on the display for approximately 5 seconds and then finish with 100.0%.
6. The unit is now calibrated and in the normal operating mode.

2.8.2 Calibration to Room Air

The MaxBlend 2+p can quickly be calibrated to room air (20.9%).

To calibrate to room air:



1. Connect the air supply line (pressure differential alarm may sound). Verify the sensor is plugged into the O2 sensor port and connected to the sensor cable  **DO NOT** connect oxygen supply line at this time. (If preferred, room-air calibration may be performed by removing the sensor from the O2 sampling port and detaching the flow diverter. If using this method, the gas-supply lines may remain attached.)
2. Using the ON/OFF key , make sure the MaxBlend 2+p is in the power on mode.
3. Rotate the FiO2 control knob to the 21% stop. Allow a few minutes for the reading to stabilize.
4. Press the Unlock key  to unlock the keypad. Note the LOW, SMART ALARM, CAL, and HIGH icons will begin to flash indicating the SET OPERATING MODE. Verify device is in O2 mode.

- Press the Calibration key  on the keypad. The word "CAL" will appear on the display for approximately 5 seconds and then finish with 20.9%.
- The unit is now calibrated and in the normal operating mode.

2.8.3 Zero Calibration

A zero calibration resets the zero point of the pressure sensor, the measurement when no pressure is connected. Perform a zero calibration if the monitor displays a non-zero pressure reading when no pressure is connected.

To zero the device:

- Ensure no pressure is connected to the device and open to room air.
- Unlock the device by pressing the unlock key .
- Select pressure mode by pressing the power/mode button until  is shown on the display.
- Press the CAL/0 button. The display will flash '0.0' until the zeroing has been completed.
- Verify the pressure display reads 0.0 cmH₂O once zeroing is complete.

2.9 Flowmeter Operation

- Adjust the flowmeter to the desired setpoint as read by the center of the float ball.
 - To increase flow—turn knob counter-clockwise
 - To decrease flow—turn knob clockwise
- Check the toggle bleed switch to ensure it is in the appropriate position.
 - For a low flow blender the bleed toggle switch should be turned on (up position) if the total combined flow from the blender is less than 3LPM.
 - For a high flow blender the bleed toggle switch should be turned on (up position) if the total combined flow from the blender is less than 15LPM.
 - At delivered flows greater than the above limits, the bleed toggle switch can be turned off (down position) to conserve gas.

 **CAUTION:** Failure to activate the bleed as described above may result in inaccurate oxygen concentrations from the blender. However, the MaxBlend 2+p will always display the actual delivered concentration.

 **CAUTION:** The outlets of this device are capable of delivering pressure as high as the inlet pressure. Ensure that the devices that carry the gas from the blender to the patient prevent excessive pressure to the patient.

3.0 PERFORMANCE CHECK

Prior to placing the MaxBlend 2+p into clinical use, perform the following tests.

 **WARNING:** If the MaxBlend 2+p does not function as described on the next page, contact your Maxtec Distributor or contact a Maxtec Certified Service Technician at:

Maxtec
2305 South 1070 West
Salt Lake City, UT 84119
(385) 549-8000 or (800) 748-5355

 **DO NOT** use the MaxBlend 2+p until correct performance has been verified.

3.1 Blender Safety Check

NOTE: Before proceeding, ensure that the high oxygen alarm set point control is OFF [display reads (--)], and that the low oxygen alarm set point control is below 20%.

PROCEDURE	BLENDER RESPONSE
1. Connect the blender to 50 ±5 PSIG air/oxygen gas sources. Adjust the blender control knob to 60%. Turn the bleed toggle switch on (up position) and adjust the flowmeter to a minimum of 2 LPM.	No response. Monitor display reads 60% ±3%.

PROCEDURE	BLENDER RESPONSE
2. Disconnect the 50 PSIG AIR source from the MaxBlend 2+p. NOTE: The blender must be flowing gas for the alarm to activate.	Audible alarm sounds. Monitor display reads 100% ±3%.
3. Reconnect 50 PSIG AIR source to the MaxBlend 2/MaxBlend 2+p.	Audible alarm stops. Verify the monitor display reads 60% ±3%.
4. Disconnect 50 PSIG OXYGEN source from the MaxBlend 2+p.	Audible alarm sounds. Monitor display reads 20.9% ±3%.
5. Reconnect 50 PSIG OXYGEN to the MaxBlend 2+p.	Audible alarm stops. Verify the monitor display reads 60% ±3%.
6. Adjust both air and oxygen inlet regulators to 0 PSIG.	No response.
7. Remove air inlet hose at regulator and insert end into beaker of water.	No response.
8. Slowly raise pressure of oxygen regulator to 50 PSIG and back to 0 PSIG while observing air hose end in beaker.	No bubbles should be observed. Audible alarm sounds.
9. Dry and reattach air inlet hose to regulator.	No response.
10. Remove oxygen inlet hose at regulator, and insert end into beaker of water.	No response.
11. Slowly raise pressure of air regulator to 50 PSIG and back to 0 PSIG while observing oxygen hose end in beaker.	No bubbles should be observed. Audible alarm sounds.
12. Dry and reattach oxygen inlet hose to regulator.	No response.

4.0 PRESSURE MONITOR TESTS

4.1 Pressure Monitor Accuracy Test

A Pressure Monitor Accuracy Test is recommended annually to verify performance of the pressure monitor. The process involves applying a known pressure to the device and confirming the readings using a calibrated manometer (pressure gauge). Use a calibrated manometer with accuracy ≤ ±0.5 cmH₂O.

- Turn the device on and zero the pressure reading. (See Section 2.8.3)
- Use a clean syringe with a 4-way stopcock or tee and create the test setup shown.
- Slowly apply pressure with the syringe to several test points across the range of pressure measurement.  **WARNING:** Do not exceed 60 cmH₂O. Over pressurizing the device may result in permanent damage to the pressure sensor.
- The readings between the device and the calibrated manometer should be within ±1.0 cmH₂O. Contact Maxtec technical service if the device fails to function as expected.

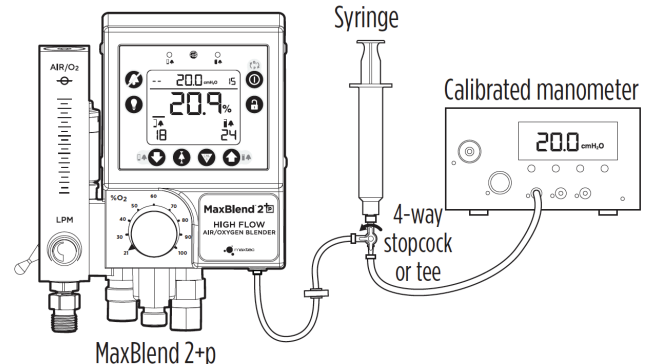

5.0 TROUBLESHOOTING

PROBLEM: Oxygen concentration discrepancy between oxygen concentration selection knob and actual reading on display, greater than 3%.

POTENTIAL CAUSES AND SOLUTIONS:

- Bleed is turned off. Turn bleed toggle switch on. Refer to section 2.9, Flowmeter Operation.
- Monitor out of calibration. Calibrate. Refer to section 2.8, Calibration Procedure.
- Sensor exhausted. Replace sensor. Refer to section 6.2.
- Gas supply contaminated. Contact Maxtec for repair of the MaxBlend 2/MaxBlend 2+p.
- Blender out of calibration. Contact Maxtec for repair.

PROBLEM: Pressure differential alarm sounding.

POTENTIAL CAUSES AND SOLUTIONS:

- Inlet pressure differences of 20 PSI or more. Correct pressure difference.
- Pressure alarm not calibrated properly. Contact Maxtec for repair.
- MaxBlend 2+p blender operation out of calibration. Contact Maxtec for repair.

PROBLEM: Inlet pressure has supply loss, no audible pressure differential alarm.

POTENTIAL CAUSES AND SOLUTIONS:

- Reed alarm cap damaged or defective. Contact Maxtec for repair.

PROBLEM: Selected oxygen concentration accurate only when gas pressures are equal.

POTENTIAL CAUSES AND SOLUTIONS:

- MaxBlend 2+p balance module not functioning properly. Contact Maxtec for repair.

PROBLEM: Blank display.

POTENTIAL CAUSES AND SOLUTIONS:

- Batteries not installed. Install batteries. Refer to section 2.1.1, Battery Installation.
- Battery completely dead. Replace batteries. Refer to section 2.1.1, Battery Installation.
- Monitor defective. Contact Maxtec for repair.

PROBLEM: Partial or distorted display.

POTENTIAL CAUSES AND SOLUTIONS:

- Monitor damaged. Contact Maxtec for repair.

PROBLEM: Sensor will not calibrate.

POTENTIAL CAUSES AND SOLUTIONS:

- Sensor cell exhausted. Replace sensor. Refer to section 6, Replacing O₂ sensor.
- Sensor cable defective. Return to Maxtec.
- Monitor defective. Contact Maxtec for repair.

PROBLEM: Sensor will calibrate, but takes too long or does not return to 21% ±2% oxygen in air (2 to 5 minutes) when performing calibration.

POTENTIAL CAUSES AND SOLUTIONS:

- Disposable oxygen sensor damaged or defective. Replace sensor. Refer to section 6.2, Replacing O₂ sensor.

PROBLEM: Sensor will calibrate, but reading at any constant level drifts more than ±3% over a 24 hour period.

POTENTIAL CAUSES AND SOLUTIONS:

- Barometric pressure change since last calibration. Recalibrate. Refer to section 2.8, Calibration Procedures.
- Room or gas temperature went below 59°F (15°C) or above 104°F (40°C). Correct temperature and recalibrate.

PROBLEM: Low battery icon.

POTENTIAL CAUSES AND SOLUTIONS:

- If, at any time, the low battery icon is displayed on the LCD readout, the batteries should be replaced as quickly as possible.

PROBLEM: E01: Sensor voltage is too low to perform a valid calibration.

POTENTIAL CAUSES AND SOLUTIONS:

- Manually attempt a new calibration. Refer to section 2.8, Calibration Procedures.
- If unit repeats this error more than three times, contact Maxtec's Customer Service Department for possible sensor replacement.

PROBLEM: E02: No sensor attached.

POTENTIAL CAUSES AND SOLUTIONS:

- Disconnect the sensor and reconnect, making sure the male plug is fully inserted into the receptacle. The analyzer should now perform a new calibration with the error cleared.
- If the error still persists, remove the batteries, wait 30 seconds, then reinstall, to perform a factory reset and diagnostic on the analyzer. The analyzer should again perform a new calibration with the error cleared.
- Contact Maxtec Customer Service Department if the error code cannot be cleared.

PROBLEM: E03: No valid calibration data available.

POTENTIAL CAUSES AND SOLUTIONS:

- Make sure unit has reached thermal equilibrium and perform a calibration routine. Refer to section 2.8, Calibration Procedures.

PROBLEM: E04: Battery below minimum operating voltage.

POTENTIAL CAUSES AND SOLUTIONS:

- Replace batteries. A medium priority alarm will sound every 25 seconds until the batteries are replaced or become too dead to sound the alarm. Refer to section 2.1.1, Battery Installation.

PROBLEM: E05: Sensor voltage is too high to perform a valid calibration.

POTENTIAL CAUSES AND SOLUTIONS:

- Manually attempt a new calibration. Refer to section 2.8, Calibration Procedures.
- If unit repeats this error more than three times, contact Maxtec's Customer Service Department for possible sensor replacement.

PROBLEM: E06: Non-compatible oxygen sensor.

POTENTIAL CAUSES AND SOLUTIONS:

- Disconnect the sensor and reconnect, making sure the male plug is fully inserted into the receptacle. The analyzer should now perform a new calibration with the error cleared.
- If the error still persists, remove the batteries, wait 30 seconds, then reinstall, to perform a factory reset and diagnostic on the analyzer. The analyzer should again perform a new calibration with the error cleared.
- Contact Maxtec Customer Service Department if the error code cannot be cleared.

PROBLEM: E07: Sensor signal is not stable enough to perform a valid calibration.

POTENTIAL CAUSES AND SOLUTIONS:

- Wait for displayed oxygen reading to stabilize when calibrating the device at 100% oxygen.
- Wait for unit to reach thermal equilibrium. Please note that this can take up to one half hour, if the device is stored in temperatures outside the specified operating temperature range.

PROBLEM: E08: Battery voltage is too low to perform a valid calibration.

POTENTIAL CAUSES AND SOLUTIONS:

- Replace batteries. Refer to section 2.1.1, Battery Installation.

E09: Pressure out of range, too high. The pressure applied to the monitor port has exceeded the device maximum pressure. Remove the pressure or adjust within the allowable range.

E10: Pressure out of range, too low. The pressure applied to the monitor port has exceeded the device minimum pressure. Remove the pressure or adjust within the allowable range.

E11: Pressure zero calibration unstable. Ensure pressure is stable and attempt a new zero calibration. If error persists, contact Maxtec technical service.

E12: Pressure CAL/O out of range.

E13: Pressure sensor error. No valid pressure sensor data. Remove batteries from device to reset and perform a new CAL/O. If error persists, contact Maxtec technical service.

NOTE: Use only the Maxtec-approved Max-550E sensor described in section 11.0, Spare Parts and Accessories. The Max550E sensor is equipped with an authentication chip to ensure the monitor is used with an approved sensor.

NOTE: The operator must be facing the device and positioned within 4 meters to distinguish the visual alarm indicators. Audible alarms can be distinguished as long as the operator is in the same room, and the ambient noise level is typical for a clinical setting.

6.0 CLEANING AND DISINFECTING

The external surfaces of the device, and its accessories, can be cleaned and disinfected using the process detailed below. Under normal use conditions, the sensing surfaces of the sensor should not become contaminated. If you suspect that the sensing face of the sensor or internal surfaces of the flow diverter have become contaminated, these items should be discarded and replaced. Store the device in a clean, dry location when not in use.

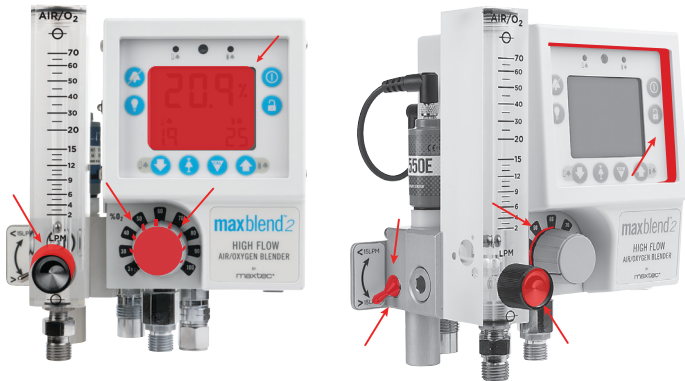

To clean and disinfect:

1. Ensure battery drawer is closed and sensor/diverter are inserted into their port.
2. Using disposable Super Sani-Cloth germicidal wipes (medical-grade 2-in-1 cleaning/disinfecting wipes), remove all visible contamination from the external surfaces of the device and its accessories. Be sure to closely inspect and remove contamination from seams and recesses on the device that may trap contaminants. Wipe with clean paper towel to remove debris and bioburden.
3. After all visible contamination is removed, use a second germicidal wipe to thoroughly wet the surfaces of the device and accessories. Allow to remain wet for 4 minutes. Use additional wipes, if needed, to assure surfaces are wetted continuously for 4 minutes.
4. Allow device to air dry completely.
5. Visually inspect the device for visible contamination. Repeat cleaning/disinfection process if visible soil remains.

- ⊘ **DO NOT** allow the liquid or spray to penetrate the device.
- ⊘ **DO NOT** spray cleaning solution directly onto the sensor port, bleed muffler or buzzer openings.

NOTE: Be sure to thoroughly clean and disinfect the areas depicted. These regions are contacted during normal use and may contribute to cross contamination if not disinfected properly. To prevent overcleaning, if sanitation is required, sanitization should be limited to once between each patient use. Other necessary cleanings should be done with a germicidal wipe or mild detergent and water

NOTE: The device should be discontinued from service if material degradation or cracking are observed.

CAUTION: Excessive rubbing of labels may cause them to become illegible.

- ⊘ **DO NOT** immerse the device or sensor into liquid decontamination agents.
- ⊘ **DO NOT** use strong solvent cleaners.

⊘ **DO NOT** allow cleaning liquids to contact the face of the sensor as this may impair the readings of the sensor.

⊘ **DO NOT** attempt to sterilize the device with steam, ethylene oxide or irradiation.

⊘ **DO NOT** allow liquids to enter the pressure monitor port.

7.0 SERVICE AND MAINTENANCE

7.1 Maintenance

Maxtec recommends that the Performance Check listed in section 3.0 is performed at least once a year.

When using the MaxBlend 2+p with a medical-grade compressed air source, it is recommended that an air inlet watertrap/filter be attached to the air inlet of the MaxBlend 2+p prior to use. Contaminants from hospital air lines may compromise the function of the MaxBlend 2+p.

Maxtec recommends that the MaxBlend 2+p be overhauled and serviced at a minimum of every three years.

Repair of this equipment must be performed by a Maxtec Certified Service Technician experienced in the repair of this device.

7.2 Replacing O2 Sensor

The oxygen sensor is designed to operate for two years under normal use conditions. The oxygen sensor should be replaced whenever any of the problems listed in section 4.0, Troubleshooting dictate the need to do so.

To replace the O2 sensor:

1. Remove the sensor from the sensor monitor port.
2. Remove the sensor from the sensor cable.
3. Install a new O2 sensor with flow diverter and attach to the sensor cable.
4. Calibrate the sensor following the instructions for calibration listed in section 2.8.

7.3 Monitor Alarm Testing

- Testing of alarms should be performed on a **yearly basis**.
- To check the low alarm, adjust the low alarm setting to 23%, or higher, and expose the sensor to room air (20.9%). The low alarm LED should flash with the alarm sound.
- To check the high alarm, adjust the low alarm setting to 17%, or lower, and the high alarm setting to 18% and expose the sensor to room air (20.9%). The high alarm LED should flash with the alarm sound. If one, or both alarms malfunction, contact a Maxtec Certified Service Technician.

8.0 ABBREVIATION GUIDE

TERM	DESCRIPTION
Air/O2	Mixture of compressed air and oxygen
°C	Degrees Celsius
CGA	Compressed Gas Association
DISS	Diameter Indexed Safety System
°F	Degrees Fahrenheit
FiO2	Fractional Concentration of Inspired Oxygen
O2	Oxygen
LPM	Liters Per Minute
PSIG	Pounds Per Square Inch Gauge

9.0 SPECIFICATIONS

9.1 Instrument Specifications

Weight (unpacked)..... 5.3 lbs. (2.4 kg.)
Power Source..... Four "AA" alkaline batteries, 1.5 V each

Power specification	7.5V(MAX) == 1.9W/250mA(MAX)
Battery Life.....	5000 hours (continuous operation, no alarming)
Expected Service Life	7 Years
Oxygen Measurement Range.....	0% to 100% oxygen
Display Resolution.....	0.1% oxygen
O2 Concentration Adjustment Range.....	21% to 100% O2
Gas Supply Pressure.....	The gas supplies must provide clean, dry, medical-grade air and oxygen at a pressure of 30 to 75 PSIG (2.0 to 5.2 BAR). Air and oxygen must be within 20 PSI (1.3 BAR). Optimal performance is achieved at 50 PSIG inlet pressures.
Pressure Drop	Less than 6 PSIG (0.4 BAR) @ 50 PSIG (3.4 BAR) supply pressures and 10 LPM flow rate
Sensor Bleed Flow	0.1LPM @ 50 PSIG (3.4 BAR)
Bleed Flow (toggle ON)	3 LPM for low flow blender and 13 LPM for high flow blender
Outlet Flow Range.....	0-30 LPM for low flow blender and 2-100 LPM for high flow blender with inlet pressures at 50 PSIG (3.4 BAR)
Mixed Gas Stability* Ambient Operating Conditions.....	±1% oxygen
Operating Temperature Range	59°F to 104°F (15°C to 40°C)
Relative Humidity Range.....	0-95%, non-condensing
Ambient Storage Conditions Temperature Range.....	5°F to 122°F (-15°C to 50°C)
Flowmeter accuracy**	+/-10% of indicated value or 0.5 LPM whichever is greater, with inlet pressure set to 50PSIG.

*The delivered oxygen concentration will remain constant within ±1% of the set point value with constant inlet pressures. The displayed value may vary more than this due to sensor accuracy, age, environmental conditions, and the length of time since last sensor calibration.

**Position the device such that the flowmeters are vertical to ensure accuracy.

9.2 Pressure Monitor Specifications

Pressure measurement range.....	-15.0 - 60.0 cmH ₂ O
Display resolution.....	0.5 cmH ₂ O
Pressure Accuracy	±1.0 cmH ₂ O
High Pressure Alarm Range	1-60 cmH ₂ O, Off
Low Pressure Alarm Range	Off, 1-30 cmH ₂ O
Pressure Alarm Resolution.....	1 cmH ₂ O

9.3 Alarm Specifications

Pressure Differential Alarm Activation	When supply pressures differ by 20 PSI (1.3 BAR) or more alarm is activated
Low Oxygen Alarm Range.....	15%-99% (>1% lower than high alarm)
High Oxygen Alarm Range.....	16%-100% (>1% higher than low alarm) (according to IEC 60601-1-8 Audible Alarms in Medical Equipment)
Alarm Volume (all priorities).....	72 dB(A) ± 7 dB(A) at 1 meter

9.4 O2 Sensor Specifications

Total accuracy*	±3% actual oxygen level over full operating temperature range
Oxygen Measurement Accuracy	±1% oxygen
Linearity	± 1% at constant temperature and pressure
Error Over Operating Temp Range	±3% oxygen, maximum
Response Time to 90% of Final Reading*	@ 77°F (25°C) ≤20 seconds
Storage Temperature Range.....	5°F to 122°F (-15°C to 50°C)
Expected Useful Life.....	1,500,000 O2% hours (approx. 2 years average use)

*The accuracy of the oxygen monitor is not affected by supply gas inlet pressure to the blender, however, pressures below 50 PSIG may result in a longer response time.

NOTE: All specifications assume the following standard environmental conditions, unless specified otherwise:

- Ambient and sample gas temperatures of 77°F (25°C)
- Barometric pressure of 30 inHg (102 kPa)
- Ambient relative humidity of 50%
- Sample gas relative humidity of 0%

10.0 FACTORS INFLUENCING CALIBRATION

10.1 Temperature Effect

The MaxBlend 2+p Monitor will hold calibration and read correctly within +/-3% when in thermal equilibrium within the operating temperature range.

The device accuracy will be better than +/-3% if operated at the same temperature at which it was calibrated. The device must be thermally stable when calibrated and allowed to thermally stabilize after experiencing temperature changes before reading is accurate. For these reasons, the following is recommended:

1. Allow adequate time for the sensor to equilibrate to a new ambient temperature. Please note that this can take up to one half hour, if the device is stored in temperatures outside the specified operating temperature range.
2. For best results, perform the calibration procedure at a temperature close to the temperature where analysis will occur.

10.2 Pressure Effect

Changes in barometric pressure can affect the oxygen reading. A 1% change in the barometric pressure results in an error of 1% of actual reading (Example: If you are reading a 50% oxygen mix and the barometric pressure drops from 30kPa to 29kPa, the reading will drop to: 50% x (29/30) = 48.3%. Maxtec recommends that you recalibrate after changing point-of-use elevation by more than 500 feet (150m).

10.3 Humidity Effect

Humidity in the sample gas will affect the oxygen reading. Maxtec recommends that the gas delivered to the MaxBlend 2+p be medical-grade, clean, and dry. Refer to ISO 7396-1 for further details.

10.4 Exposure to Anesthetic Gases

Because of the unique chemistry of the oxygen sensors provided with the MaxBlend 2+p, there are no significant effects when exposed to commonly used anesthetic gases; however, the monitor is not designed for exposure to flammable gas mixtures (See WARNING page 2).

INTERFERENT	VOLUME % DRY	INTERFERENCE IN O2%
Nitrous Oxide	60%, balance O2	<1.5%
Halothane	4%	<1.5%
Enflurane	5%	<1.5%
Isoflurane	5%	<1.5%
Helium	50%, balance O2	<1.5%
Sevoflurane	5%	<1.5%
Desflurane	15%	<1.5%

NOTE: Balance mixture 30% O2/70%N2O, unless otherwise specified.

11.0 SPARE PARTS AND ACCESSORIES

DESCRIPTION	PART NUMBER
MAX550E Oxygen Sensor	R140P02-001
ACCESSORIES DESCRIPTION	
Sensor Cable	R228P49
Adjustable Pole Mount Bracket	R100P22
Pole Mount Bracket	R100P26
Large Wall Mount, Dovetail Bracket	RP05P09
Compact Wall Mount, Dovetail Bracket	RP05P07
Maxtec-Approved External Power Supply	R230P10
Wall Mount Large Bracket	RP05P09
10' Dual Blender hose (DISS)	R129P01

Repair of this equipment must be performed by a Maxtec Certified Service Technician, experienced in the repair of this device.

Equipment in need of repair shall be sent to:

Maxtec
Service Department
2305 South 1070 West
Salt Lake City, Ut 84119
1.800.748.5355
(Include RMA number issued by Customer Service)

12.0 THEORY OF OPERATION

12.1 Operational Diagram

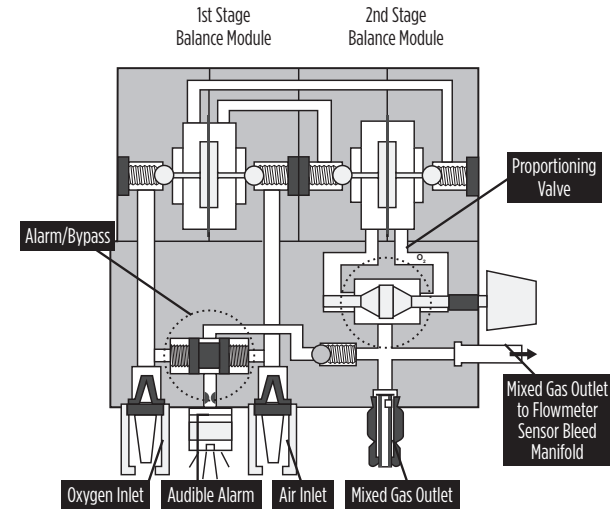

12.2 Mixing Operation

The MaxBlend 2+p is designed to utilize two 50 PSIG (3.4 BAR) gas sources. The two gas sources enter through the air and oxygen inlet connectors located on the bottom of the MaxBlend 2+p. Each inlet connector incorporates a 30 micron particulate filter. Once through the filters, each gas passes through a duckbill check valve, which prevents possible reverse gas flow from either the air or the oxygen supply systems.

The two gases then pass through a two-stage balance regulator. The purpose of this regulator is to equalize the operating pressures of the air and oxygen gas sources. Once these pressures have been balanced, the gases are proportioned according to the oxygen concentration selected on the oxygen concentration selection knob. The oxygen concentration knob allows the clinician to select a desired oxygen concentration from 21% to 100% O₂. From this point, the mixed gas flows to the outlet port.

12.3 Gas Outlet

There are three gas outlets on the MaxBlend 2+p. One is a fixed acrylic flowmeter, the other two are auxiliary ports (one on the bottom of the unit, and one on the right side). These outlets are capable of delivering combined metered flows of 0-30 LPM for the low flow model and 0-120 LPM for the high flow model. The auxiliary outlet ports are fitted with an automatic shut-off valve. The flow of gas from either outlet port is automatically initiated by attaching a pneumatic device (such as a flowmeter) to the outlet port.

Regardless of whether or not the outlet has any device connected to it, a minimal gas bleed flow of 0.1 LPM flows from the MaxBlend 2+p sensor port on the left side of the blender. It is from this bleed flow that the gas is analyzed by the oxygen sensor. In addition, a toggle switch is provided allowing the user to activate an additional gas bleed, which ensures the blender has sufficient flow to function accurately when the total flow delivered to the patient is below a certain minimum threshold. For a low flow model, this additional bleed should be activated if the total flow delivered to the patient is less than 3 LPM.

For a high flow model, the additional bleed should be activated if the total flow delivered to the patient is less than 15 LPM. At delivered flows greater than these limits, the bleed toggle can be deactivated to conserve oxygen.

CAUTION: Failure to activate the bleed as described above may result in significant drift in the oxygen concentration delivered to the patient.

12.4 Alarm/Bypass Function

The MaxBlend 2+p includes a pressure differential alarm which provides an audible alarm if gas source pressures differ by 20 PSI (1.3 BAR) (nominal) or more, or if there is a gas supply failure of one of the source gases. This alarm is generated by a reed alarm located in a cap on the bottom of the MaxBlend 2+p.

The primary purpose of the alarm is to audibly warn the operator of an excessive pressure drop or depletion of either source gas pressure. Should both gas pressures increase or decrease simultaneously, an alarm will not activate.

If either source gas pressure drops, the outlet pressure will drop similarly, as the mixed gas is always balanced to that of the lower gas source.

The gas bypass function operates in unison with the alarm. Once the pressure alarm is activated, the bypass function is actuated and the gas with the higher pressure flows directly to the outlet port, bypassing the mixing function of the MaxBlend 2+p. The oxygen concentration flowing out of the MaxBlend 2+p will be that of the gas with the higher pressure. In the alarm/bypass mode, the blender will deliver oxygen (100%) or medical air (21%) until pressures have been restored to a differential of 6 PSI or less (0.4 BAR).

If the MaxBlend 2+p is set to deliver 21% and the OXYGEN source pressure is reduced enough to produce a 20 PSI (1.3 BAR) differential, the unit may not alarm because it will continue to deliver 21% concentration according to the setting. If the setting is moved slightly from 21%, the pressure differential alarm will sound. Similarly, if the MaxBlend 2+p is set to deliver 100% and the AIR source pressure is reduced or lost, the unit may not alarm because it will continue to deliver 100% concentration.

13.0 FLOW CHARACTERISTICS

The outlet pressure of the MaxBlend 2+p decreases as the total flow rate increases. The total flow rate is the measurement of the total flow from all outlet ports. The charts below indicate the pressure drop that occurs for both low flow, and high flow, models at 3 inlet pressure settings; 30 PSIG (2.07 BAR), 50 PSIG (3.45 BAR), and 75 PSIG (5.17 BAR).

The fixed acrylic flowmeter on the left side of the MaxBlend 2+p has been pressure compensated to accommodate for the pressure loss through the blender at each flow rate, using an inlet pressure of 50 PSIG.

Flow Rate -vs- Pressure Drop:

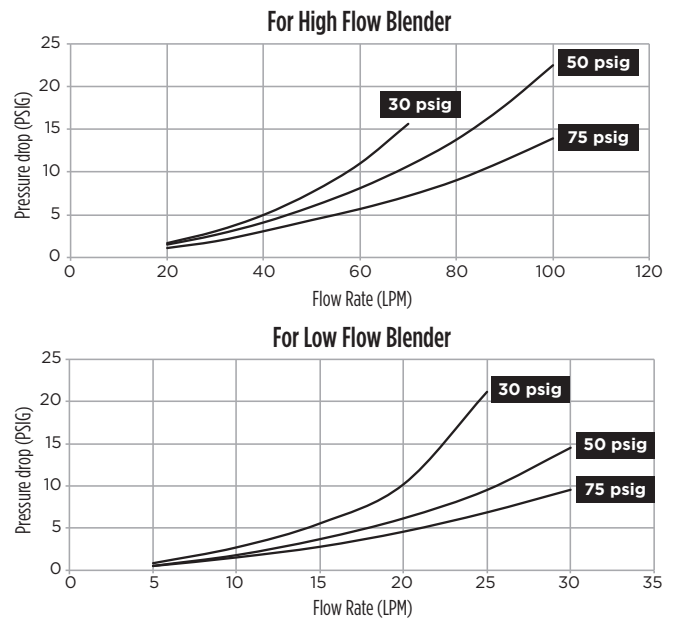

14.0 ELECTROMAGNETIC COMPATABILITY

The MaxBlend 2+p is suitable for the electromagnetic environment of typical hospital settings. The user should assure that it is used in such an environment.

During the immunity testing described below the MaxBlend 2+p will monitor oxygen and pressure within specification.

! WARNING: Portable RF communications equipment (including peripherals such as antenna cables and external antennas) should be used no closer than 30 cm (12 inches) to any part of the MaxBlend 2+p, including cables specified by the manufacturer. Otherwise, degradation of the performance of this equipment could result.

! WARNING: The MaxBlend 2+p should not be used adjacent to or stacked with other equipment. If adjacent or stacked use is necessary, the MaxBlend 2+p should be observed to verify normal operation. If operation is not normal, the MaxBlend 2+p or the other equipment should be moved.

! WARNING: Use of accessories, transducers and cables other than those specified or provided by the manufacturer of this equipment could result in increased electromagnetic emissions or decreased electromagnetic immunity of this equipment and result in improper operation.

! WARNING: Avoid exposure to known sources of EMI (electromagnetic interference) such as diathermy, lithotripsy, electrocautery, RFID (Radio Frequency Identification), and electromagnetic security systems such as anti-theft/electronic article surveillance systems, metal detectors. Note that the presence of RFID devices may not be obvious. If such interference is suspected, reposition the equipment if possible, to maximize distances.

ELECTROMAGNETIC EMISSIONS		
EMISSION TESTS	COMPLIANCE	ELECTROMAGNETIC ENVIRONMENT - GUIDANCE
RF Emissions CISPR 11	Group 1	The MaxBlend 2+p uses RF energy only for its internal function. Therefore, its RF emissions are very low and are not likely to cause any interference in nearby electronic equipment.
RF Emissions CISPR 11	Class A	The MaxBlend 2+p is suitable for use in all establishments other than domestic, and may be used in domestic establishments and those directly connected to the public low-voltage power supply network that supplies buildings used for domestic purposes, provided the following warning is heeded: WARNING: This equipment/system is intended for use by healthcare professionals only. This equipment/ system may cause radio interference or may disrupt the operation of nearby equipment. It may be necessary to take mitigation measures, such as re-orienting or relocating the MaxBlend 2+p or shielding the location.
Harmonic Emissions IEC 61000-3-2	NA	
Voltage fluctuations / flicker emissions IEC 61000-3-3	NA	

ELECTROMAGNETIC IMMUNITY		
IMMUNITY TEST	COMPLIANCE LEVEL	ELECTROMAGNETIC ENVIRONMENT - GUIDANCE
Electrostatic discharge (ESD) IEC 61000-4-2	± 8kV contact ± 2, 4, 8 and 15kV air	Floors should be wood, concrete or ceramic tile. If floors are covered with synthetic material, the relative humidity should be at least 30 %.
Electrical fast transient / burst IEC 61000-4-4	± 2 kV for power supply lines	Mains power quality should be that of a typical commercial or hospital environment.
Surge IEC 61000-4-5	± 1 kV differential mode	Mains power quality should be that of a typical commercial or hospital environment.
Voltage dips, short interruptions and voltage variations on power supply input lines IEC 61000-4-11	0% .5 Periods 0% 1 Period 70% 25 Periods 0% 5 sec	Mains power quality should be that of a typical commercial or hospital environment. If the user of the MaxBlend 2+p requires continued operation during power mains interruptions beyond that provided by the battery, it is recommended that the MaxBlend 2+p is powered from an uninterruptible power supply.
Power frequency (50/60 Hz) magnetic field IEC 61000-4-8	30A/m 50 and 60Hz	Power frequency magnetic fields should be at levels characteristic of a typical location in a typical commercial or hospital environment.
Radiated fields in close proximity IEC 61000-4-39	65 A/m at 134.2 kHz (2.1 kHz PM, 50% duty cycle) 7.5 A/m at 13.56 MHz (50 kHz PM, 50% duty cycle)	Avoid exposure to known sources of EMI (electromagnetic interference) such as diathermy, lithotripsy, electrocautery, RFID (Radio Frequency Identification), and electromagnetic security systems such as anti-theft/electronic article surveillance systems, metal detectors. Note that the presence of RFID devices may not be obvious. If such interference is suspected, reposition the equipment if possible to maximize distances.
NOTE: Ur is the A/C. mains voltage prior to application of the test level.		

ELECTROMAGNETIC IMMUNITY		
IMMUNITY TEST	COMPLIANCE LEVEL	ELECTROMAGNETIC ENVIRONMENT - GUIDANCE
Conducted RF IEC 61000-4-6	3 Vrms 150 kHz to 80 MHz 6 V rms in ISM bands	The MaxBlend 2+p is suitable for the electromagnetic environment of typical hospital settings.
Radiated RF IEC 61000-4-3	3 V/m 80 MHz to 2.7 GHz	

The MaxBlend 2+p was also tested for radiated immunity to RF wireless communication equipment at the test levels below.

Frequency (Hz)	Modulation	Level V/m
385	Pulse, 18 Hz, 50% DC	27
450	FM, 1 kHz Sine, ± 5 Hz Deviation	28
710, 745, 780	Pulse, 217 Hz, 50% DC	9
810, 870, 930	Pulse, 18 Hz, 50% DC	28
1720, 1845, 1970	Pulse, 217 Hz, 50% DC	28
2450		28
5240, 5500, 5785		9

This page intentionally left blank

This page intentionally left blank



2305 South 1070 West
Salt Lake City, Utah 84119
(800) 748-5355
www.maxtec.com